

CHIFA

VETERINARY INSTRUMENTS

NARZĘDZIA WETERYNARYJNE

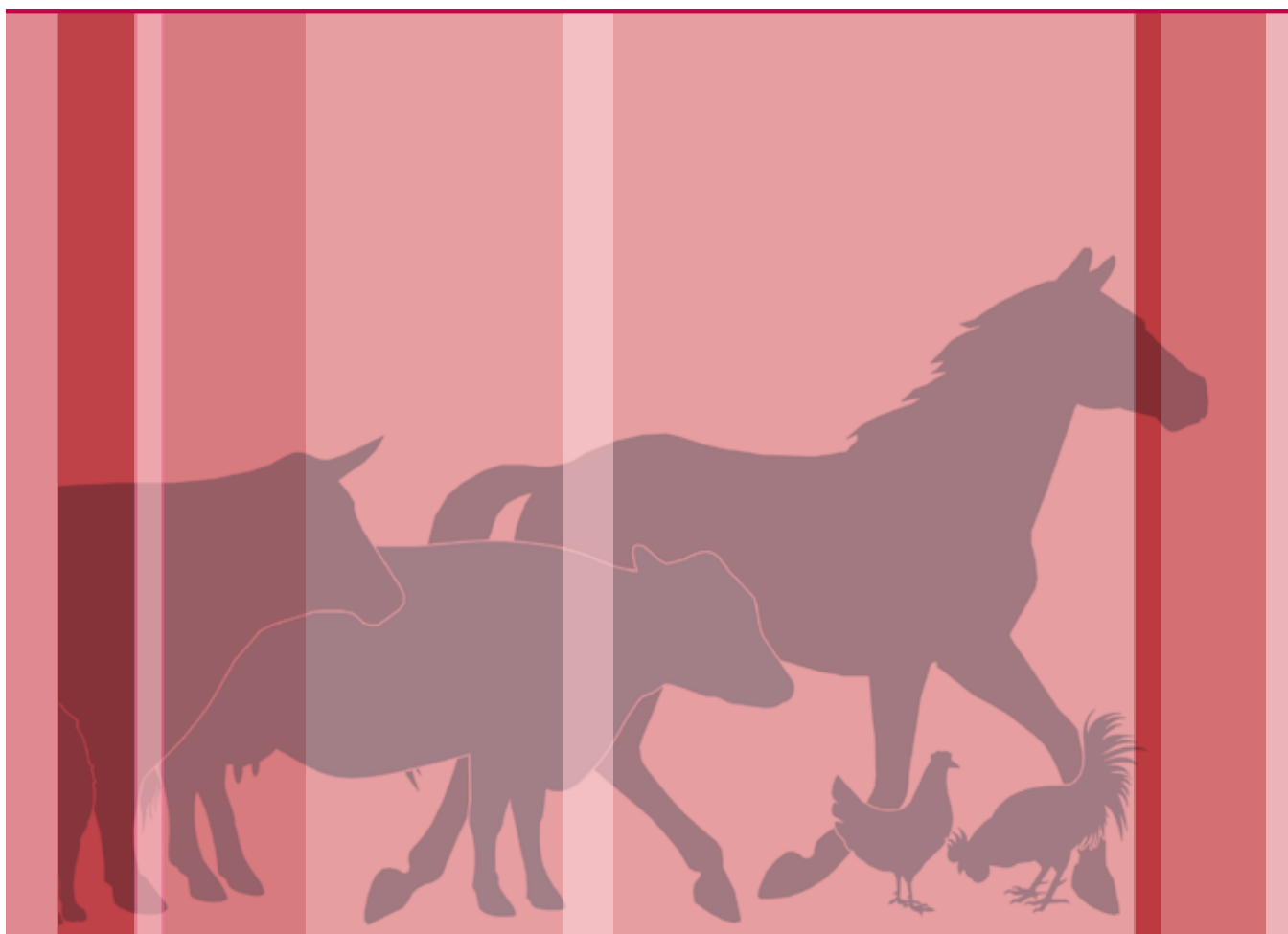



CHIFA is well known world wide as a manufacturer of more than 4000 surgical, dental and veterinary instruments.

The factory was established in 1946 and currently hires more than 1300 employees. The quality of our products and our company's brand are highly recognized in more than 50 countries all over the world.

We would like to present you full range of our veterinary instruments. All instruments are manufactured at our own plant and all pass strict quality inspection, according to ISO 13485:2003/AC:2007.

CHIFA gives 1-year long warranty over all its products.

We guarantee that all product leaving our plant are free of any material or workmanship defects.

The condition to make use of the warranty is a correct application of the instruments as well as proper provision, handling, sterilization and storage.

All instruments are made out of stainless steel with exception of products, where the final letter of the last part of the products' reference ends with L or N (eg. WR-024-420-PL, WK-022-220-PN).

The instruments have got a different surface finishing, which are coded also in the last letter segment of the symbol and mean as follows:

- B – mirror finish (eg. KE-201-000-PB)
- K – sand blast finish (eg. NH-078-140-PMK)
- S – brush finish (eg. MO-133-142-PMS)
- T – handle sand blasted and the working part mirror finished (eg. SD-033-002-PT)
- L – carbon steel, paint finish (eg. WR-024-420-PL)
- N – carbon steel, nickel finish (eg. WK-022-220-PN)

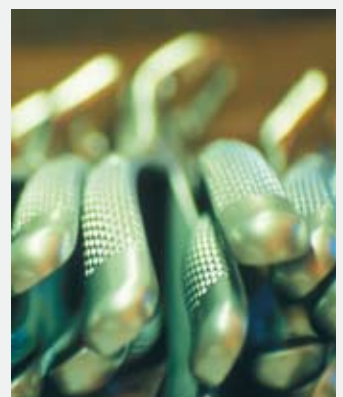

CHIFA to znany na całym świecie producent ponad 4000 narzędzi chirurgicznych, stomatologicznych oraz weterynaryjnych.

Fabryka powstała w 1946 roku i aktualnie zatrudnia ponad 1300 pracowników. Jakość i marka firmy zyskała uznanie w ponad 50 państwach na całym świecie.

Przedstawiamy Państwu kompletną ofertę narzędzi z zakresu weterynarii. Wszystkie narzędzia produkowane są w naszym zakładzie i przechodzą cykl dokładnych testów jakościowych – zgodnych z ISO 13485:2003/AC:2007.

Na produkowane narzędzia firma udziela 1-letniej gwarancji.

Gwarantujemy, że każdy produkt opuszczający naszą fabrykę jest wolny od jakichkolwiek defektów w materiale jak i wykonaniu.

Warunkiem skorzystania z gwarancji jest stosowanie produktów zgodnie z ich przeznaczeniem oraz właściwe przygotowanie, obchodzenie się z nimi i sterylizacja.

Wszystkie instrumenty wykonane są ze stali nierdzewnej, z wyjątkiem narzędzi, których symbol zakończony jest literą L lub N (np. WR-024-420-PL, WK-022-220-PN).

Narzędzia posiadają różne wersje wykonania powierzchni, które zakodowane są również w ostatniej literze symbolu narzędzia i oznaczają odpowiednio:

- B – wykonanie błyszczące (np. KE-201-000-PB)
- K – wykonanie matowe (np. NH-078-140-PMK)
- S – wykonanie matowe (np. MO-133-142-PMS)
- T – rękojeść wykonanie matowe a część pracująca wykonanie błyszczące (np. SD-033-002 PT)
- L – stal węglowa, wykonanie lakierowane (np. WR-024-420-PL)
- N – stal węglowa, wykonanie niklowane (np. WK-022-220-PN)



**BULL HOLDERS
POSKRAMIACZE DLA BYDŁA**



HARMS
WE-035-200-PS
20 cm, 8"



HARMS
WE-135-200-PS
20 cm, 8"

**PIG RING AND PIG RING APPLICATOR
KÓŁKO NOSOWE DLA ŚWIŃ I KLESZCZE DO JEGO ZAKŁADANIA**



WE-030-265-PN
26,5 cm, 10 3/8 "



WE-033-045-PN

średnica wewnętrzna 28 mm, 1 1/8"
inside diameter 28mm, 1 1/8"

BULL RINGS AND BULL RING APPLICATORS
KÓŁKA NOSOWE DLA BUHAJÓW I KLESZCZE DO ICH ZAKŁADANIA



WE-050-058-PN

średnica wewnętrzna 58 mm, 2 5/16"
inside diameter 58 mm, 2 5/16"



WE-040-051-PN

średnica wewnętrzna 51 mm, 2"
inside diameter 51mm, 2"



WE-150-058-PN

średnica wewnętrzna 58 mm, 2 5/16"
inside diameter 58 mm, 2 5/16"



WE-042-320-PN

32 cm, 12 5/8"



WE-142-320-PN

32 cm, 12 5/8"

PIG CATCHERS
PĘTLE - POSKRAMIACZE DLA ŚWIŃ

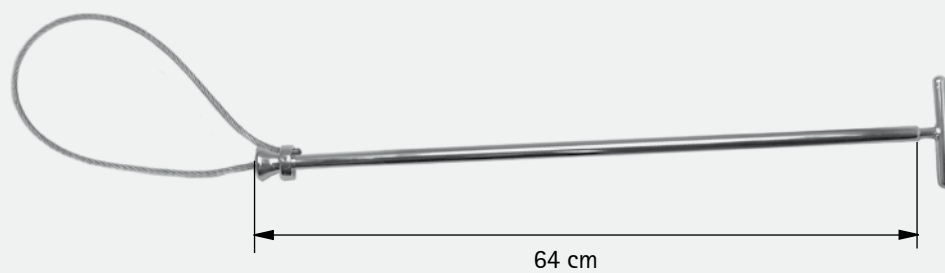

WE-011-004-PN

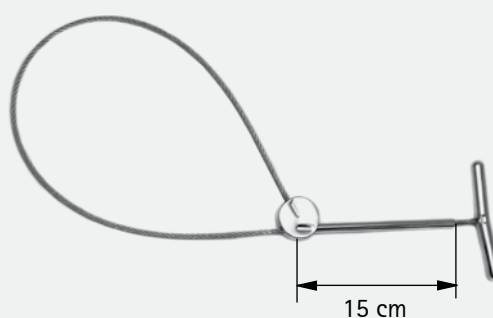

SCHOETTLE
WE-012-005-PN

MOUTH GAG FOR DOGS
ROZWIERACZ SZCZĘKOWY DLA PSÓW

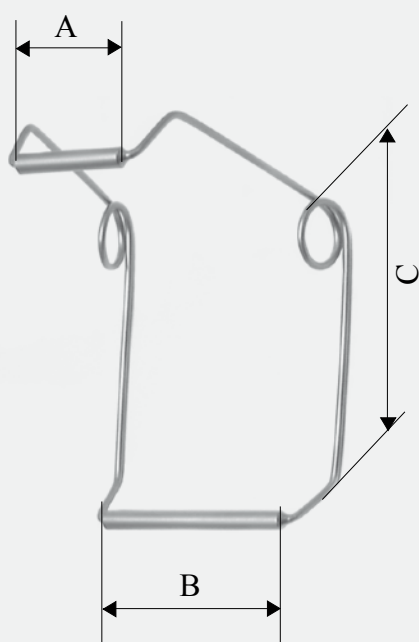

	A [mm]	B [mm]	C [mm]
WS-001-040-PMK	25	40	47
WS-001-067-PMK	31	46	50
WS-001-105-PMK	28	50	82
WS-001-150-PMK	36	56	115
WS-001-175-PMK	52	70	150

CURRY COMB
GRZEBIEŃ DLA PSÓW

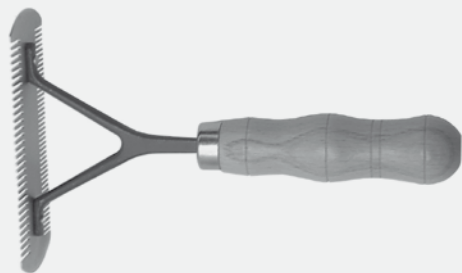

WP-001-901-PL
21 cm, 8 1/4"

NAIL NIPPERS
CAŻKI DO PAZNOKCI

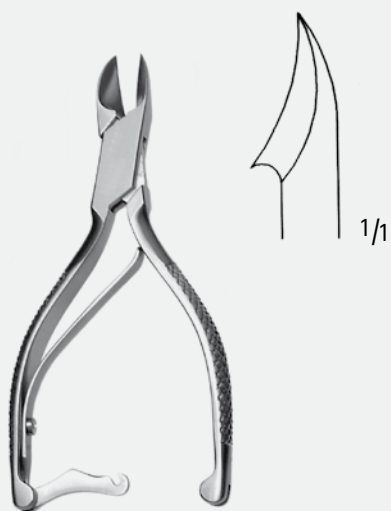

MO-011-135-PMS
13,5 cm, 5 1/4"



MO-024-155-XPMK
15,5 cm, 6 1/8"



MO-133-142-PMS
14 cm, 5 1/2"



MO-211-135-PMS
13,5 cm, 5 1/4"

**NAIL SCISSORS
NOŻYCKI DO PAZNOKCI**



MO-009-090-EZMS

9 cm, 3 1/2"

zagięte/curved

MO-009-100-EZMS

10 cm, 4"

zagięte/curved

MO-009-110-EZMS

11 cm, 4 3/8"

zagięte/curved

**MARKING FORCEPS
KLESZCZE DO ZNAKOWANIA**



15,5 cm, 6 1/8"



WE-048-000-PS



WE-048-001-PS



WE-048-002-PS



WE-048-003-PS



WE-048-004-PS



13,5 cm, 5 1/4"

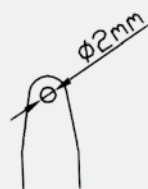

WE-028-135-PMK

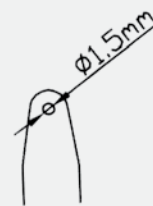

WE-128-135-PMK

**TRIMMING AND IDENTIFICATION SCISSORS
NOŻYCZKI DO STRZYŻENIA I ZNAKOWANIA ZWIERZĄT**



WE-069-135-EZMS
13,5 cm, 5 1/4"

t=0,25 ząbki na ostrzu dolnym, zagięte
T=0,25 - with one blade serrated, curved



WE-068-170-EPMS
17 cm, 6 3/4"

t=0,25 ząbki na ostrzu dolnym
ostrza proste, ramiona zagięte
T=0,25 - with one blade serrated
straight, curved handles

WE-038-170-PMK
17 cm, 6 3/4"

ostrza proste, ramiona zagięte
straight, curved handles

WE-039-160-ZMK
16 cm, 6 1/4"
zagięte/curved

WE-139 -160-ZMK
16 cm, 6 1/4"

t=0,5 ząbki na ostrzu dolnym, zagięte
T=0,5 - with bottom blade serrated, curved



WE-069 -160-ZMK
16 cm, 6 1/4"

t=0,25 ząbki na ostrzu dolnym, zagięte
T=0,25 - with bottom blade serrated, curved

WE-239 -160-ZMK
16 cm, 6 1/4"

t=0,5 ząbki na ostrzu górnym, zagięte
T=0,5 - with upper blade serrated, curved

TRIMMING AND IDENTIFICATION SCISSORS
NOŻYCY DO STRYŻENIA I ZNAKOWANIA ZWIERZĄT



WE-045-155-ZMK

15,5 cm, 6 1/8"

zagięte/curved



WE-045-170-ZMK

17 cm, 6 3/4"

zagięte/curved



NF-004-140-PMK

14 cm, 5 1/2"

proste/straight



NF-001-160-PMK

16 cm, 6 1/4"

proste/straight

**SURGICAL POCKET INSTRUMENTS SET
MAŁY ZESTAW CHIRURGICZNY**

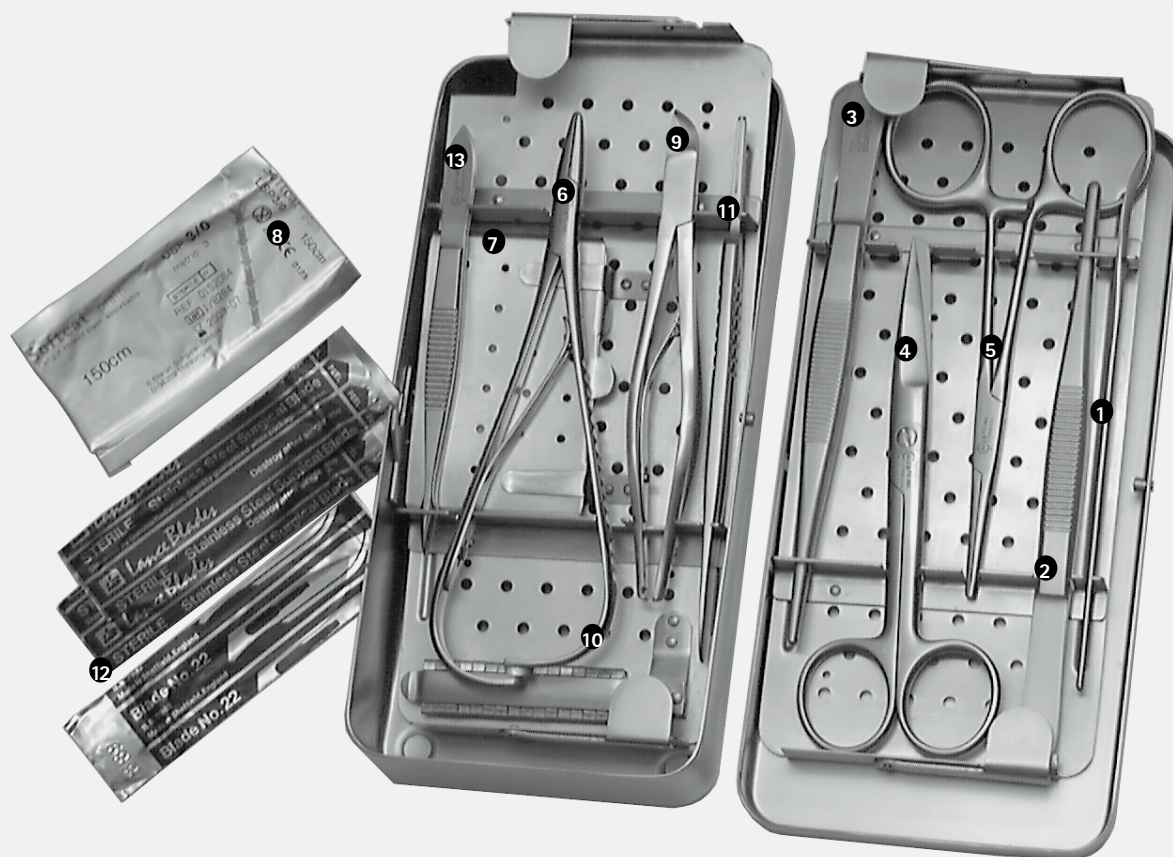

HO-075-170-PMS

- | | | | |
|----|--|----|---|
| 1 | 1 Zagłębnik listkowy (HO-015-135-PMK) | 1 | 1 Probe, myrtle leaf-shaped (HO-015-135-PMK) |
| 2 | 1 Pinceta anatomiczna dł. 14,5 cm | 1 | 1 Dressing Forceps 14,5 cm long |
| 3 | 1 Pinceta chirurgiczna dł. 14,5 cm | 1 | 1 Tissue Forceps 1x2 teeth, 14,5 cm long |
| 4 | 1 Nożyczki chirurgiczne proste, jeden koniec ostry
dł 13 cm (NH-279-130-EPMK) | 1 | 1 Straight Operating Scissors, sharp-blunt
13 cm (NH-279-130-EPMK) |
| 5 | 1 Kleszczyki naczyniowe typu KOCHER, 1x2 ząbki,
proste dł 13 cm (KN-158-130-PMS) | 1 | 1 KOCHER Artery Forceps, straight,
13 cm (KN-158-130-PMS) |
| 6 | 1 Iglotrzymacz MATHIEU (IM-037-140-PMS),
dł. 14 cm (HO-075-170-PMK) | 1 | 1 MATHIEU Needle Holder (IM-037-140-PMS)
14 cm (HO-075-170-PMK) |
| | 1 Iglotrzymacz HEGAR (IM-035-160-PMK)
dł. 16 cm (HO-175-170-PMK) | 1 | 1 HEGAR Needle Holder (IM-035-160-PMK)
16 cm (HO-175-170-PMK) |
| 7 | 6 Igiel chirurgicznych w asortymencie | 6 | 6 Suture Needles, assorted |
| 8 | 1 Nici chirurgiczne | 1 | 1 Surgical Threads |
| 9 | 1 Kleszczyki uniwersalne do nakładania i zdejmowania
klamerek MICHEL (HO-036-120-PMK), dł.12 cm | 1 | 1 MICHEL Clip Applying and Removing
Forceps (HO-036-120-PMK) |
| 10 | 20 Klamerek MICHEL | 20 | 20 MICHEL Wound Clips |
| 11 | 1 Uchwyt do noży wymiennych Nr 4 (TH-096-004-PMK) | 1 | 1 Scalpel Handle No 4 (TH-096-004-PMK) |
| 12 | 3 Ostrza wymienne sterylne | 3 | 3 Sterile Surgical Blades |
| 13 | 1 Pinceta do odłamków kostnych typu HUNTER
(HO-010-105-PMK), dł. 11 cm | 1 | 1 HUNTER Splinter Forceps, 11 cm (HO-010-105-PMK) |

SCALPEL BLADE HANDLES
TRZONKI DO SKALPELI



TH-095-003-PMK
12 cm, 4 3/4"



TH-096-004-PMK
13 cm, 5 1/8"



TH-097-003-PMK
16 cm, 6 1/4"

TH-195-003-PMK
z podziałką
with scale

TH-196-004-PMK
z podziałką
with scale

TH-197-003-PMK
z podziałką
with scale

SURGICAL SCISSORS
NOŻYCHKI CHIRURGICZNE



MAYO

NH-078-140-PMK
14 cm, 5 1/2"

NH-078-140-ZMK
14 cm, 5 1/2"

NH-078-170-PMK
17 cm, 6 3/4"

NH-078-170-ZMK
17 cm, 6 3/4"

proste/straight

zagięte/curved

SURGICAL SCISSORS - NOŻYCKI CHIRURGICZNE



NH-085-200-PMK
20 cm, 8"

NH-085-230-PMK
23 cm, 9"

proste/straight

NH-085-200-ZMK
20 cm, 8"

NH-085-230-ZMK
23 cm, 9"

zagięte/curved

SIMS



NH-086-200-PMK
20 cm, 8"

NH-086-230-PMK
23 cm, 9"

proste/straight

NH-086-200-ZMK
20 cm, 8"

NH-086-230-ZMK
23 cm, 9"

zagięte/curved

SIMS



NH-279-130-PMK
13 cm, 5 1/8"

NH-279-130-EZMK
13 cm, 5 1/8"

NH-279-145-PMK
14,5 cm, 5 3/4"

NH-279-145-EZMK
14,5 cm, 5 3/4"

NH-279-165-PMK
16,5 cm, 6 1/2"

NH-279-165-ZMK
16,5 cm, 6 1/2"

NH-079-185-PMK
18,5 cm, 7 1/4"

NH-079-185-ZMK
18,5 cm, 7 1/4"

proste/straight

zagięte/curved



NH-280-130-PMK
13 cm, 5 1/8"

NH-280-130-EZMK
13 cm, 5 1/8"

NH-280-145-PMK
14,5 cm, 5 3/4"

NH-280-145-EZMK
14,5 cm, 5 3/4"

NH-280-165-PMK
16,5 cm, 6 1/2"

NH-280-165-ZMK
16,5 cm, 6 1/2"

NH-080-185-PMK
18,5 cm, 7 1/4"

NH-080-185-ZMK
18,5 cm, 7 1/4"

proste/straight

zagięte/curved

SURGICAL SCISSORS - NOŻYCKI CHIRURGICZNE

NH-281-130-PMK
13 cm, 5 1/8"

NH-281-145-EPMK
14,5 cm, 5 3/4"

NH-281-165-PMK
16,5 cm, 6 1/2"

NH-081-185-PMK
18,5 cm, 7 1/4"

proste/straight



NH-281-130-ZMK
13 cm, 5 1/8"

NH-281-145-ZMK
14,5 cm, 5 3/4"

NH-281-165-ZMK
16,5 cm, 6 1/2"

NH-081-185-ZMK
18,5 cm, 7 1/4"

zagięte/curved

PREPARATORY SCISSORS
NOŻYCKI PREPARACYJNE



METZENBAUM

NN-148-145-PMK
14,5 cm, 5 3/4"

proste/straight

NN-148-145-ZMK
14,5 cm, 5 3/4"

zagięte/curved



METZENBAUM

NN-185-160-PMK
16 cm, 6 1/4"

NN-185-185-PMK
18,5 cm, 7 1/4"

proste/straight

NN-185-160-ZMK
16 cm, 6 1/4"

NN-185-185-ZMK
18,5 cm, 7 1/4"

zagięte/curved

AUTOPSY SCISSORS
NOŻYCKI SEKCYJNE



NS-014-230-PMK
3 cm, 9"

SUTURE SCISSORS
NOŻYCKI DO SZWÓW



NS-110-115-PMK
11,5 cm, 4 1/2"

SCISSORS FOR DRAINS
NOŻYCKI DO DRENÓW



NH-095-130-PMK
13 cm, 5 1/8"

DRESSING SCISSORS
NOŻYCKI DO MATERIAŁÓW OPATRUNKOWYCH



LISTER

NH-074-145-PMK
14,5 cm, 5 3/4"



NH-074-180-PMK
18 cm, 7"



proste/straight

NH-076-130-PMK
13 cm, 5 1/8"

NH-076-145-PMK
14,5 cm, 5 3/4"

NH-076-185-PMK
18,5 cm, 7 1/4"



INTESTINAL SCISSORS
NOŻYCKI JELITOWE



NH-073-210-PMK
21 cm, 8 1/4"

TOWEL CLAMPS
SPINAKI DO SERWET



BACKHAUS

HO-128-090-EPMK
9 cm, 3 1/2"



HO-128-110-EPMK
11 cm, 4 3/8"



HO-128-135-EPMK
13,5 cm, 5 1/4"



HEMOSTATIC FORCEPS
KLESZCZYKI NACZYNIOWE



HALSTED



KN-082-125-XPBK
12,5 cm, 5"



KN-082-125-XZBK
12,5 cm, 5"

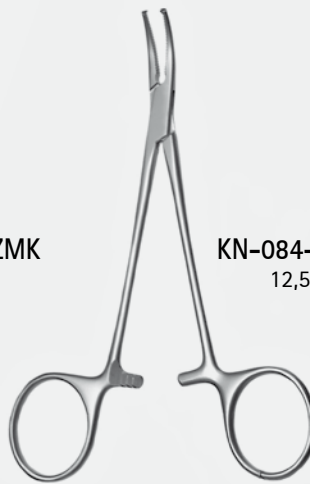

HALSTED



KN-084-125-XPBK
12,5 cm, 5"



KN-084-125-XZBK
12,5 cm, 5"

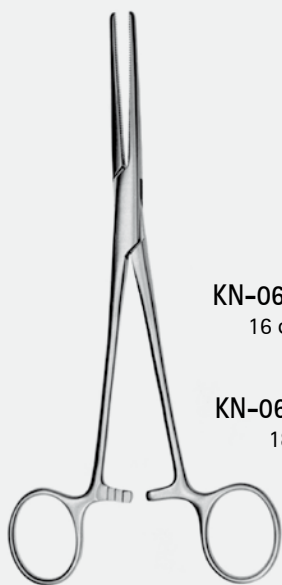

PEAN



KN-063-160-PMK
16 cm, 6 1/4"



KN-063-160-ZMK
16 cm, 6 1/4"

KN-063-180-PMK
18 cm, 7"

KN-063-180-ZMK
18 cm, 7"

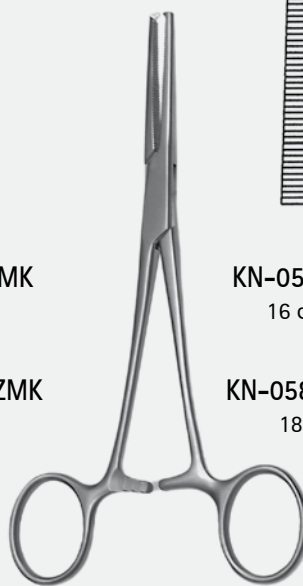

KOCHER



KN-058-160-PMS
16 cm, 6 1/4"



KN-058-180-PMS
18 cm, 7"



KN-058-160-ZMS
16 cm, 6 1/4"

KN-058-180-ZMS
18 cm, 7"

**HEMOSTATIC FORCEPS
KLESZCZYKI NACZYNIOWE**



CRILE

KN-074-160-EPMK
16 cm, 6 1/4"



KN-074-160-EZMK
16 cm, 6 1/4"

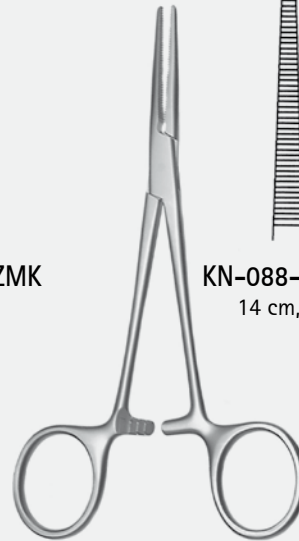
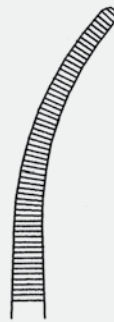

CRILE

KN-088-140-PMK
14 cm, 5 1/2"



KN-088-140-ZMK
14 cm, 5 1/2"



PEAN

KN-412-130-EPMK
13 cm, 5 1/8"
T=0,7 mm



KN-412-130-EZMK
13 cm, 5 1/8"
T=0,7 mm



KN-424-140-EPMK
14 cm, 5 1/2"
T=0,9 mm

KN-425-140-EZMK
14 cm, 5 1/2"
T=0,9 mm



KN-201-165-PMK
16,5 cm, 6 1/2"

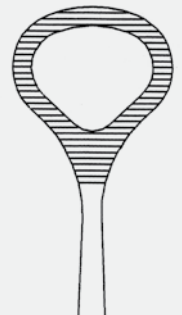

INTESTINAL FORCEPS
KLESZCZYKI JELITOWE



HO-148-215-PMK
21,5 cm, 8 1/2"



HO-148-245-PMK
24,5 cm, 9 3/4"



HO-149-215-ZMK
21,5 cm, 8 1/2"

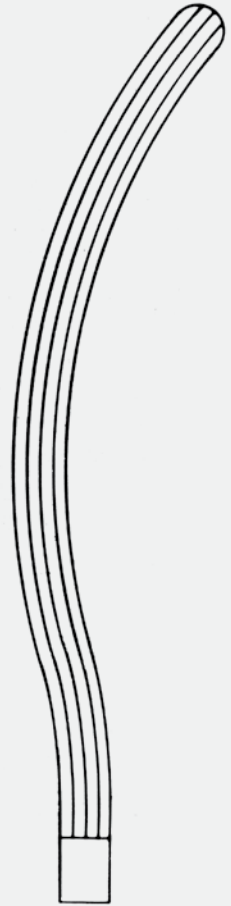

HO-149-245-ZMK
24,5 cm, 9 3/4"

INTESTINAL AND TISSUE GRASPING FORCEPS
KLESZCZYKI JELITOWE DO MATERIAŁÓW OPATRUNKOWYCH

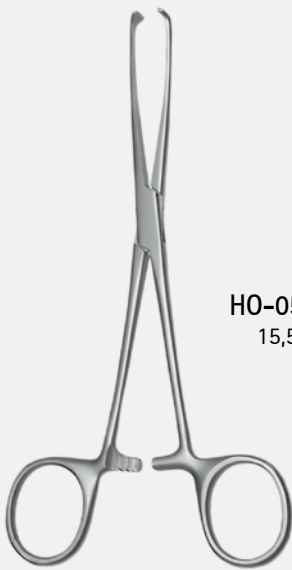

ALLIS

HO-058-155-PMK
15,5 cm, 6 1/8"

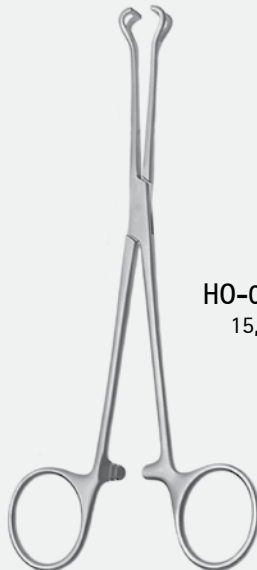

BABCOCK

HO-065-155-PMK
15,5 cm, 6 1/8"

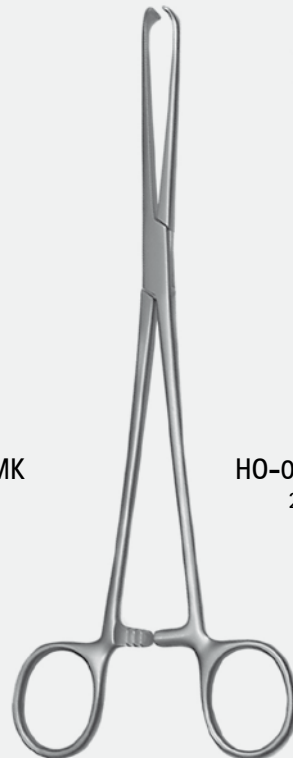

ALLIS

HO-070-200-PMK
20 cm, 8"



**SPONGE AND DRESSING FORCEPS
KLESZCZYKI DO MATERIAŁÓW OPATRUNKOWYCH**



24 cm, 9 1/2"



KG-027-240-PMK



KG-027-240-ZMK



26,5 cm, 10 1/2"

MAIER



KG-028-265-PMK

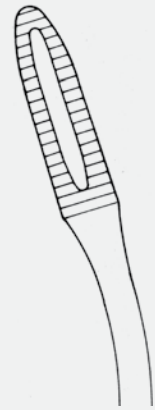

KG-028-265-ZMK

**GALL STONE SCOOPS
ŁYŻECZKI DO KAMIENI**



LUER-KÖRTE



	A
HO-069-006-PMS	6 mm
HO-069-007-PMS	7,5 mm
HO-069-011-PMS	11,5 mm

**BULLDOG CLAMPS
ZACISKACZE DO NACZYŃ**



ZK-001-060-PMS

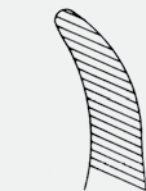

ZK-101-060-ZMS

DIEFFENBACH

6 cm, 2 3/8"



ZK-002-040-PMS



ZK-102-040-ZMS

DIEFFENBACH

4 cm, 1 9/16"

BONE CURETTES
ŁYŻECZKI KOSTNE



VOLKMANN
17 cm, 6 3/4"

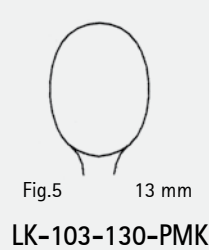
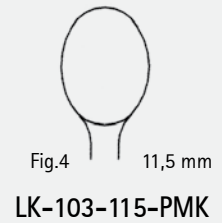
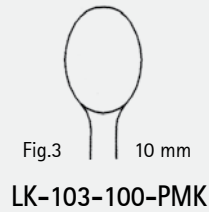
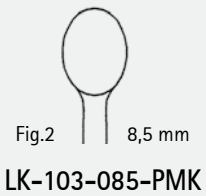
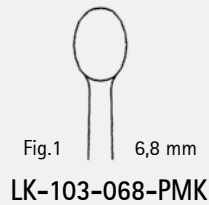
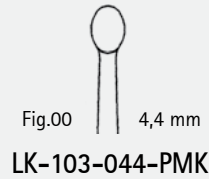
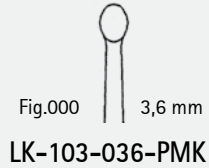
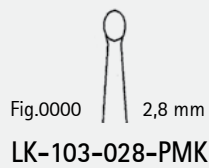

WILLIGER
LK-152-140-PMK
14 cm, 5 1/2"



WILLIGER
LK-155-145-PMK
14,5 cm, 5 3/4"

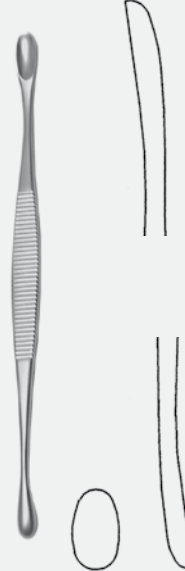

VOLKMANN
LK-156-145-PMK
14,5 cm, 5 3/4"

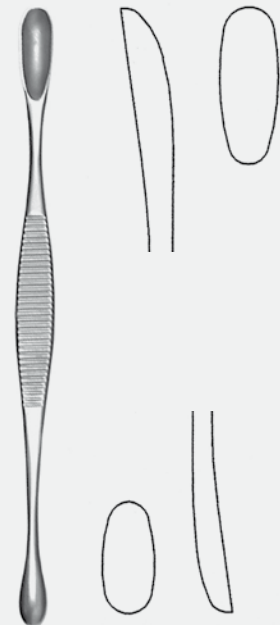

LK-156-170-PMK
17 cm, 6 3/4"

NEEDLE HOLDERS
IGŁOTRZYMACZE



MATHIEU

IM-032-200-PMS
20 cm, 8"



MATHIEU

IM-037-200-PMS
20 cm, 8"



IM-037-240-PMS
24 cm, 9 1/2"



MATHIEU

IM-137-170-PMK
17 cm, 6 3/4"



GILLIES

IM-138-160-PMK
16 cm, 6 1/4"



MATHIEU

IM-047-170-PMK
17 cm, 6 3/4"



**NEEDLE HOLDERS
IGŁOTRZYMACZE**



IM-839-140-PMK
14 cm, 5 1/2"



IM-839-140-ZMK
14 cm, 5 1/2"



IM-950-145-PZMK
14,5 cm, 5 3/4"

twarda wkładka/with TC

MATHIEU

OLSEN-HEGAR



MATHIEU

IM-939-140-PZMK
14 cm, 5 1/2"

twarda wkładka/with TC



MATHIEU

IM-947-170-PZMK
17 cm, 6 3/4"

twarda wkładka/with TC



MATHIEU

IM-932-200-PZMK
20 cm, 8"

twarda wkładka/with TC

NEEDLE HOLDERS
IGŁOTRZYMACZE



MAYO-HEGAR

IM-235-150-PMK
15 cm, 6"



IM-236-180-PMK
18 cm, 7"



IM-237-205-PMK
20,5 cm, 8 1/8"



MAYO-HEGAR
twarda wkładka/with TC

IM-920-150-EPZMK
15 cm, 6"



IM-920-180-EPZMK
18 cm, 7"



IM-920-205-EPZMK
20,5 cm, 8 1/8"

CLIPS APPLYING AND REMOVING FORCEPS
KLESZCZE DO KLAMEREK MICHELA



HEGENBARTH
HO-135-125-PMK
12,5 cm, 5"



COLLIN
HO-138-135-PMK
13,5 cm, 5 1/4"



MICHEL
HO-139-130-ZMK
13 cm, 5 1/8"

LIGATURE NEEDLES
IGŁY DO PODWIĄZYWANIA



HO-022-220-RMS
22 cm, 8 3/4"
ostra /sharp

HO-022-220-LMS
22 cm, 8 3/4"
ostra /sharp

HO-023-220-RMS
22 cm, 8 3/4"
tępa /blunt

HO-023-220-LMS
22 cm, 8 3/4"
tępa /blunt

DESCHAMPS

DESCHAMPS

SEWING NEEDLE
IGŁA DO SZYCIA



GERLACH

WE-010-150-PMS
15 cm, 6"

ABDOMINAL RETRACTOR
HAK BRZUSZNY



FARABEU

HH-215-150-PMK
15 cm, 6"

**SURGICAL HOOKS
HAKI CHIRURGICZNE**



LANGENBECK
21 cm, 8 1/4"

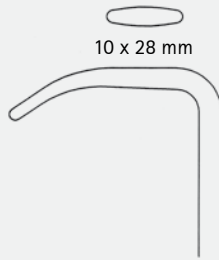

HH-241-028-PMK

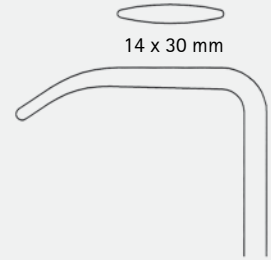

HH-241-030-PMK

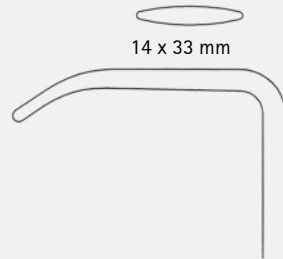

HH-241-033-PMK

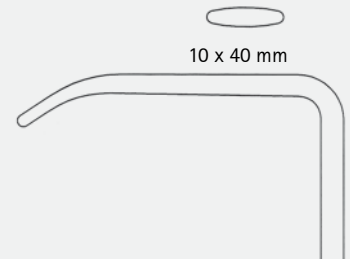

HH-241-040-PMK



16 cm, 6 1/4"



HH-257-001-PMK

ostry/sharp

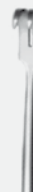

HH-257-002-PMK

ostry/sharp



HH-257-003-PMK

ostry/sharp



HH-257-004-PMK

ostry/sharp

HH-258-001-PMK

tępy/blunt

HH-258-002-PMK

tępy/blunt

HH-258-003-PMK

tępy/blunt

HH-258-004-PMK

tępy/blunt

WOUND RETRACTORS
ROZWIERACZE DO RAN



WEITLANER

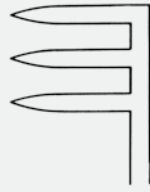

RH-299-135-PMK
13,5 cm, 5 1/4"

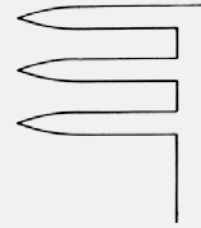

RH-299-165-PMK
16,5 cm, 6 1/2"

ABDOMINAL RETRACTORS
HAKI BRZUSZNE

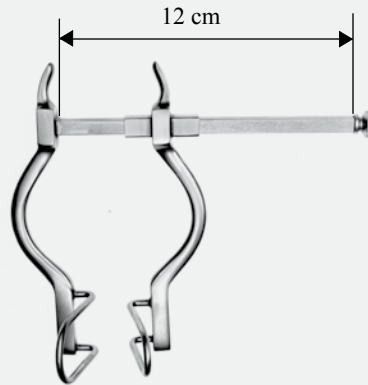

GOSSET
HH-197-045-PMK

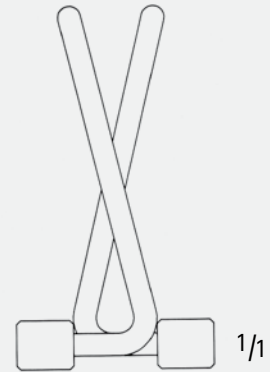

1/1

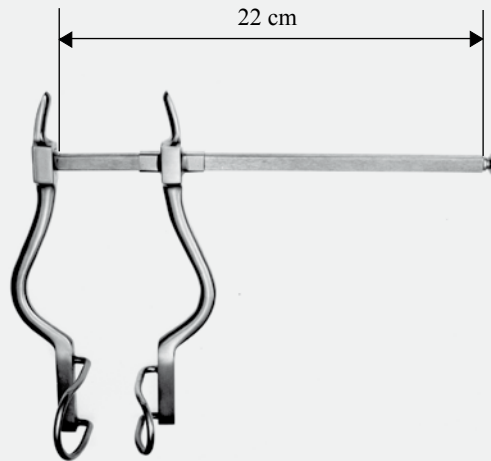

GOSSET
HH-197-057-PMK

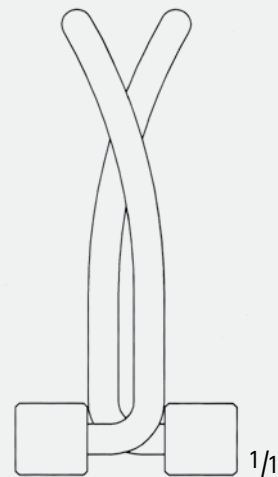

1/1

**GOUGES
DŁUTA KOSTNE**



14,5 cm, 5 3/4"

4 mm

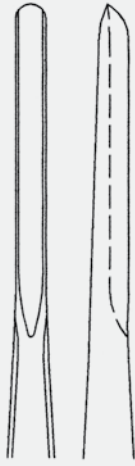

OP-050-004-PMK

6 mm



OP-050-006-PMK

8 mm

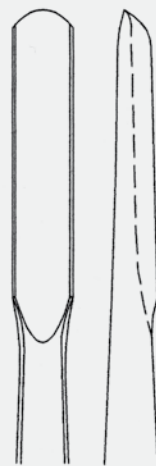

OP-050-008-PMK

10 mm

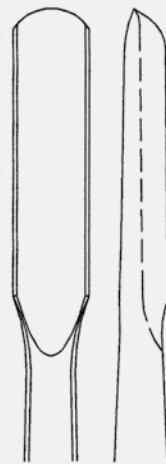

OP-050-010-PMK

12 mm

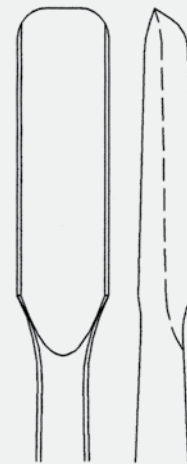

OP-050-012-PMK

ELEVATORS
PODWAŻKI KOSTNE

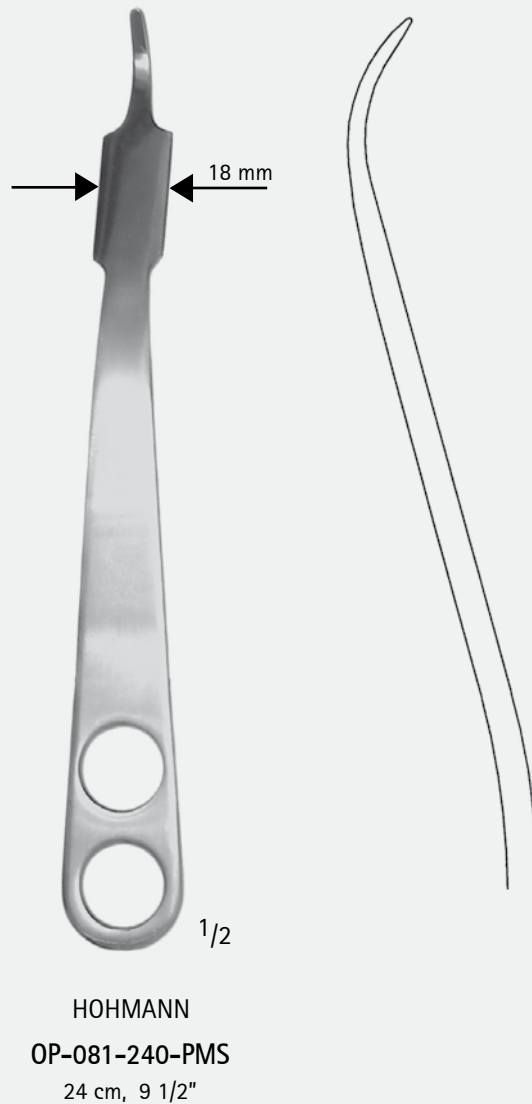
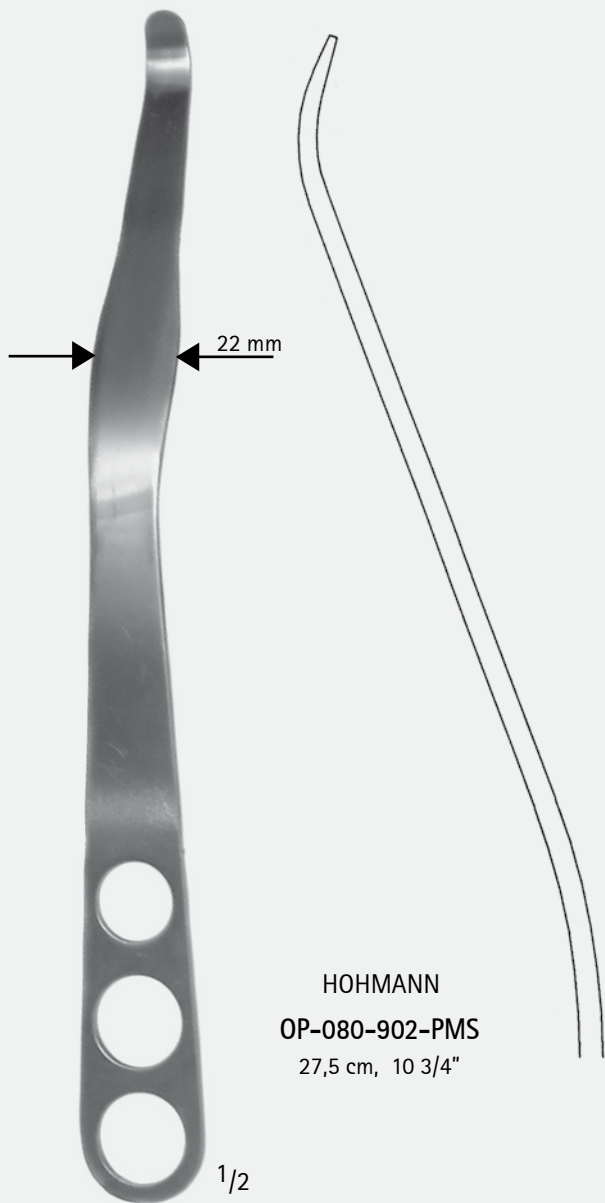

MALLET
MŁOTEK ORTOPEDYCZNY



OP-022-270-PMS
27 cm, 10 5/8 "

**BONE RONGEURS, BONE CUTTING FORCEPS
ODGRYZACZE KOSTNE, KLESZCZE DO CIĘCIA KOŚCI**

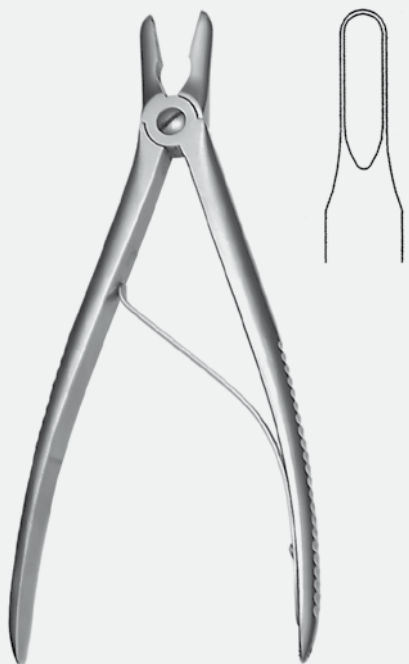

CUSHING
KK-055-006-PMK
19 cm, 7 1/2"

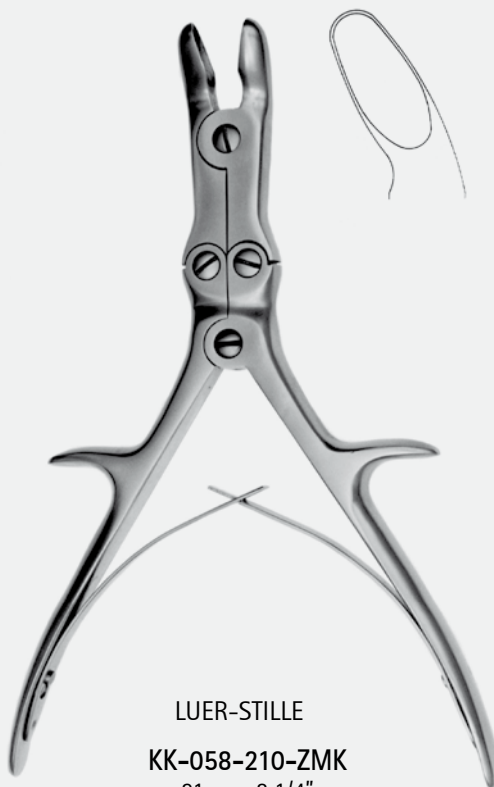

LUER-STILLE
KK-058-210-ZMK
21 cm, 8 1/4"

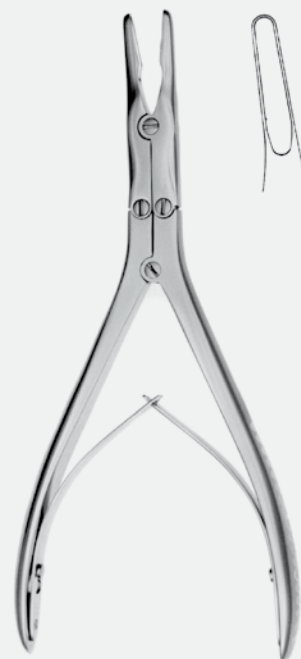

BAYER
KK-017-180-PMK
18 cm, 7"

**BONE HOLDING FORCEPS
KLESZCZE DO TRZYMANIA KOŚCI**



FARABEUF-LAMBOTTE
KK-032-255-PMK
25,5 cm, 10"

**BONE CUTTING FORCEPS
NOŻYCE KOSTNE**



LISTON
KK-035-270-PMK
27 cm, 10 5/8"

WIRE CUTTING FORCEPS, KLESZCZE DO DRUTU



KP-100-160-PMK
16 cm, 6 1/4"



OP-035-140-PMK
14 cm, 5 1/2"

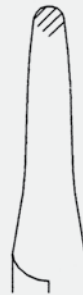

OP-035-180-PMK
18 cm, 7"



OP-033-175-PMK
17,5 cm, 6 7/8"



do drutu twardego max 1 mm
for hard wire max 1 mm

WIRE CUTTING FORCEPS
KLESZCZE DO CIĘCIA DRUTU



OP-930-020-PZMS
21,5 cm, 8 1/2"

do drutu Kirschnera Ø 2,5
for Kirschner wire Ø 2,5



OP-935-475-PMK
47,5 cm, 18 3/4"

do drutu Kirschnera Ø 6,0
for Kirschner wire Ø 6,0



OP-931-020-PZMS
23 cm, 9"

do drutu Kirschnera Ø 2,2
for Kirschner wire Ø 2,2

**ELEVATORS
DŹWIGNIE STOMATOLOGICZNE**



BEIN
SD-002-003-PT
14 cm, 5 1/2"



FLOHR
SD-004-003-LT
15 cm, 6"



FLOHR
SD-005-003-RT
15 cm, 6"



WARWICK - JAMES
SD-033-002-PT
15,5 cm, 6 1/8"

**RASPATORIES
SKROBACZKI STOMATOLOGICZNE**

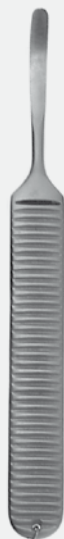

WILLIGER
ST-010-140-PMK
14 cm, 5 1/2"



WILLIGER
ST-011-160-PMK
16 cm, 6 1/4"

EXTRACTING FORCEPS
KLESZCZE EKSTRAKCYJNE



KE-201-000-PB
16 cm, 6 1/4"



Fig 17

KE-217-000-PB
16 cm, 6 1/4"



Fig 18

KE-218-000-PB
16 cm, 6 1/4"



Fig 22

KE-222-000-PB
14 cm, 5 1/2"

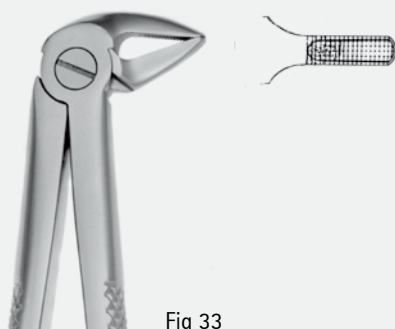

Fig 33

KE-233-000-PB
14 cm, 5 1/2"



Fig 30

KE-230-000-PB
17 cm, 6 3/4"

**TOOTH CUTTING FORCEPS
KLESZCZE DO UCINANIA KIEŁKÓW PROSIĄT**



WT-032-155-PT
15,5 cm, 6 1/8"

**DENTAL HOOK
HAK STOMATOLOGICZNY**



HH-215-150-PMK
15 cm, 6"

FARABEUF

**SCISSORS FOR CUTTING WIRE AND TAPE
NOŻYCY SKI STOMATOLOGICZNE DO BLACHY**



NP-072-110-PMK
11 cm, 4 3/8"
proste/straight

BEBE

NP-072-110-ZMK
11 cm, 4 3/8"
zagięte, tępe/curved, blunt



NP-076-110-PMK
11 cm, 4 3/8"
proste, tępe/ straight, blunt

BEBE

NP-076-110-ZMK
11 cm, 4 3/8"
zagięte, ostre/curved, sharp



NP-077-120-PMK
12,5 cm, 5"

do drutu max Ø 0,8 mm
for wire max Ø 0,8 mm

jedno ostrze ząbkowane
one blade serrated.

NEEDLE HOLDERS FOR MICROSURGERY
IMADŁA MIKROCHIRURGICZNE



IO-002-110-PMK



IO-002-110-ZMK



IO-013-110-PMK



HOOKS - HACZYKI



MP-011-003-PMK



MP-012-002-PMK



CHALAZION CURETTE
 ŁYŻECZKA DO GRADÓWKI

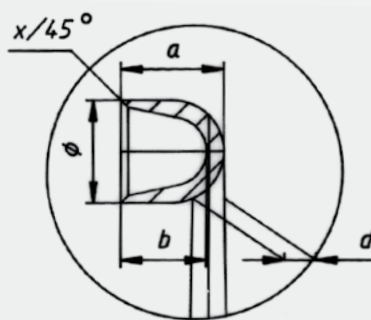

	ϕ	a	b	d	x
MP-070-010-PMK	1	1	0.5	0.5	0.1
MP-070-025-PMK	2.5	2.5	1.5	1	0.3
MP-070-030-PMK	3	3	2	1	0.3

MP-070-030-PMK
 13 cm, 5 1/8"

BLEFAROSTAT



DESMARRES
 MP-253-018-PMK
 9 cm, 3 1/2"

NEEDLE FOR REMOVING
 FOREIGN BODIES
 IGŁA DO USUWANIA CIAŁ
 OBCYCH Z OKA



MP-020-002-ZMK
 12,5 cm, 5"

FORCEP
 PINCETA



PO-001-005-PMK
 9,5 cm, 3 3/4"

MICROSURGERY SCISSORS
NOŻYCYZKI MIKROCHIRURGICZNE



NO-022-110-RMK



NO-010-085-PMK



NO-010-085-UMK



NO-010-085-ZMK

NO-022-110-LMK



NO-003-120-PMK



NO-003-120-ZMK



DELICATE SCISSORS - EYE SCISSORS
NOŻYCYZKI DELIKATNE - OCZNE



NO-051-110-PMK
11 cm, 4 3/8"

proste/straight



NO-051-110-ZMK
11 cm, 4 3/8"

zagięte/curved



FORCEPS - PINCETY

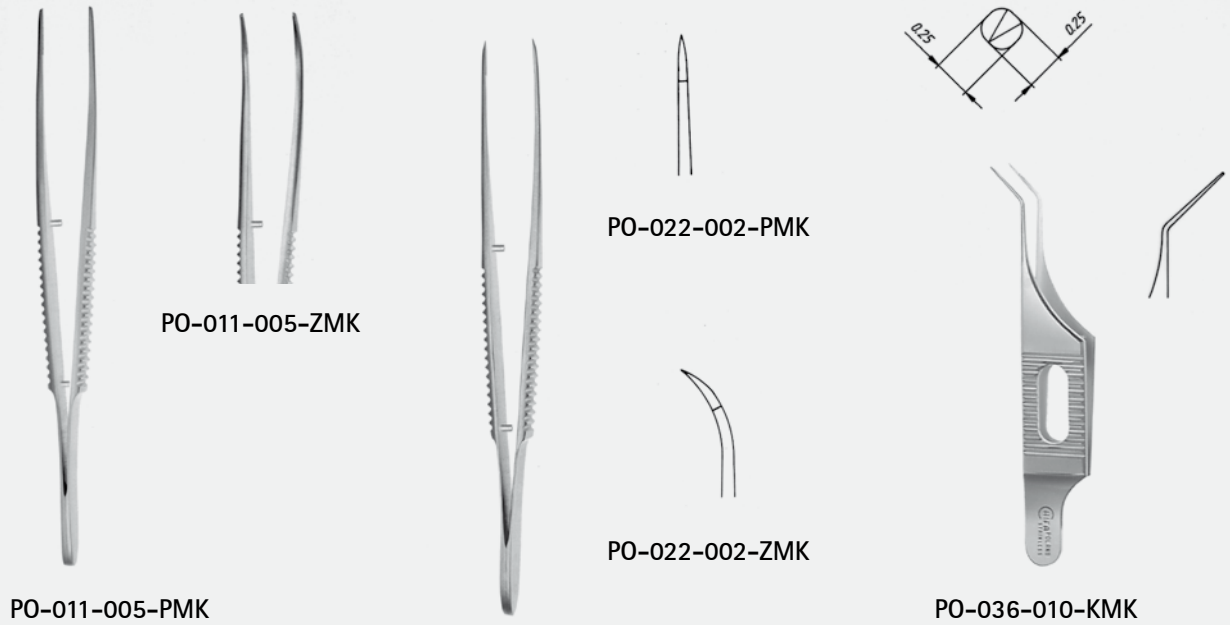

EYE SPECULUM - ROZWÓRKI OCZNE

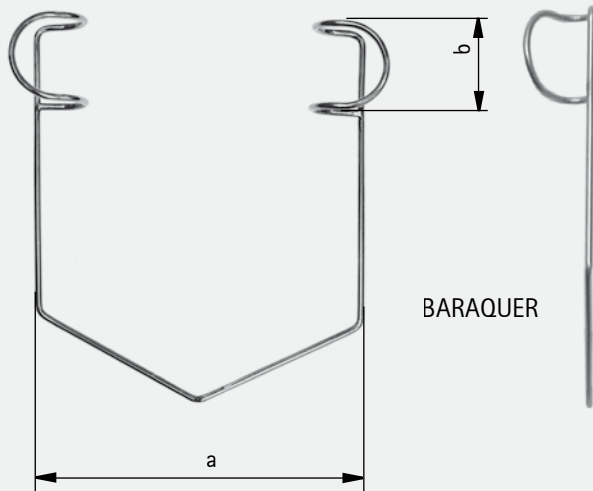

	>a<	>b<
RO-001-005-PB	27 mm	5 mm
RO-001-009-PB	34 mm	9 mm
RO-001-012-PB	42 mm	12 mm

ALLIGATOR FORCEPS
KLESZCZE DO POBIERANIA WYCINKÓW

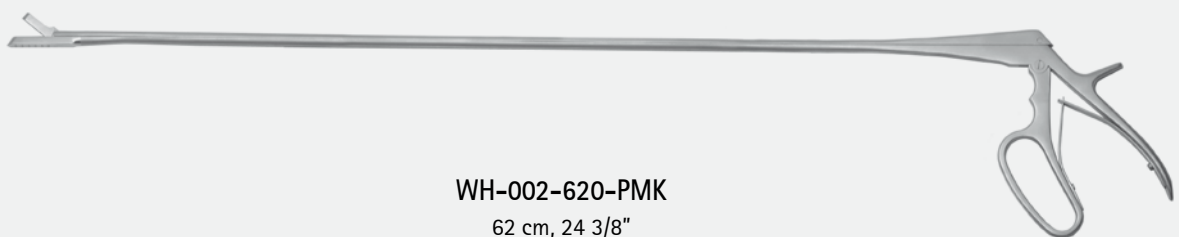

TROCAR
TROKAR



WE-003-901-PMS

RUMEN OPERATION INSTRUMENTS
NARZĘDZIA DO OPERACJI ŻWACZA



WEINGART

WZ-002-080-PMK

8 cm, 3 1/8"



BLENDINGER

WZ-023-195-PMK

19,5 cm, 7 5/8"

RUMEN OPERATION INSTRUMENTS
NARZĘDZIA DO OPERACJI ŻWACZA



WEINGART
WZ-001-280-PMK



WEINGART
WZ-004-240-PMK
24 cm, 9 1/2"

CASTRATION FORCEPS
KLESZCZE DO KASTRACJI



WK-026-185-ZT
18,5 cm, 7 1/4"
ramiona zakrzywione/curved handles

HAUSMAN



WK-026-195-PT
19,5 cm, 7 3/4"

HAUSMAN

WK-026-310-ZT
31 cm, 12 1/4"
ramiona zakrzywione/curved handles

WK-026-330-PT
33 cm, 13"

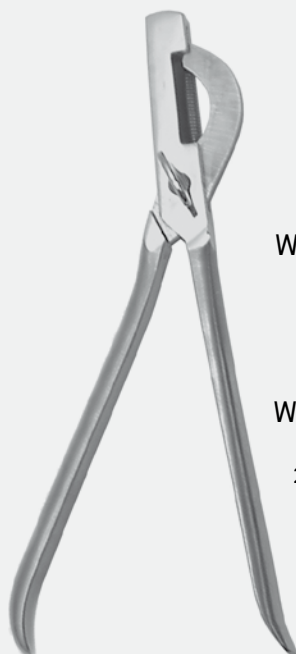

WK-034-230-PT
23 cm, 9"

HAUSMAN

WK-034-270-PT
9458
27 cm, 10 3/4"



HAUSMAN

WK-034-265-ZT
26,5 cm, 10 1/2"
ramiona zakrzywione/curved handles

CASTRATION FORCEPS
KLESZCZE DO KASTRACJI



VERBOCZY

nieruchomy docisk
fixed clamp



WK-027-310-ZT
31 cm, 12 1/4"
ramiona zakrzywione
curved handles

ruchomy docisk
movable clamp



WK-227-310-ZT
31 cm, 12 1/4"
ramiona zakrzywione
curved handles



SAND

WK-124-310-PT
31 cm, 12 1/4"



SAND

WK-125-310-PT
31 cm, 12 1/4"



REIMERS

WK-126-310-PT
31 cm, 12 1/4"

CASTRATION FORCEPS
KLESZCZE DO KASTRACJI

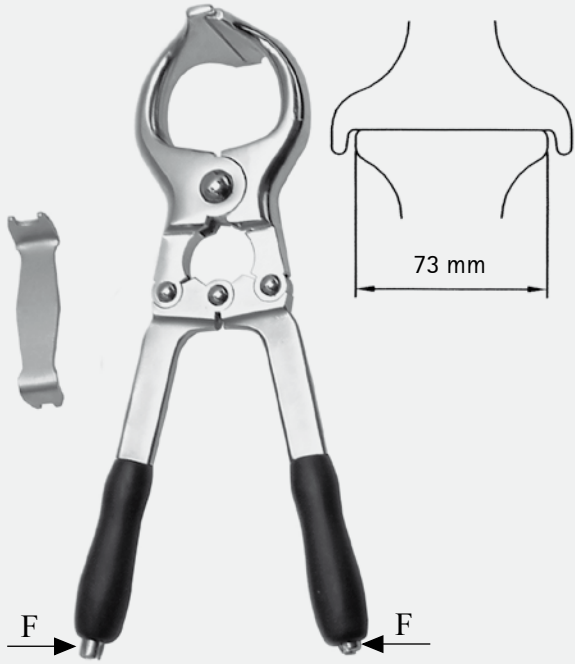

F = siła zwierania ramion
clenching strength

	długość length	siła zwierania ramion clenching strength
WK-020-360-PN	36,5 cm, 14 3/8"	F=40 N
WK-020-400-PN	40 cm, 15 3/4"	F=45 N
WK-020-480-PN	48 cm, 18 7/8"	F=35 N
WK-120-400-PN	40 cm, 15 3/4"	F=100 N
WK-120-480-PN	48 cm, 18 7/8"	F=100 N



WK-023-125-PN

KNEE PAD
NAKOLANNIK



F = siła zwierania ramion
clenching strength

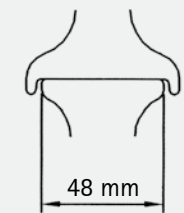

WK-021-300-PN
30 cm, 11 3/4"
F=40 N



F = siła zwierania ramion
clenching strength

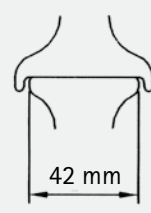

WK-022-220-PN
23 cm, 9"
F=70 N

COVAULT OVARICTOMY HOOK
HACZYK DO KASTROWANIA KOTEK



WK-010-170-PMS

17 cm, 6 3/4"

UTERINE TENACULUM AND DRESSING FORCEPS
 KLESZCZE GINEKOLOGICZNE I DO MATERIAŁÓW OPATRUNKOWYCH



KG-014-006-PMK

KG-014-008-PMK

24 cm, 9 1/2"
 MUSEUX



KG-014-010-PMK



KG-114-006-KMK

KG-114-008-KMK



24 cm, 9 1/2"
 MUSEUX



KG-114-010-KMK



SCHRÖDER

KL-035-240-PMK

24 cm, 9 1/2"



ALBRECHTSEN

WP-018-430-PMK

43 cm, 17"

SPECULA FOR SMALL ANIMALS, FOR VAGINAL AND RECTAL EXAMINATION
WZIERNIKI POCHWOWE I ODBYTNICZE DO BADANIA MAŁYCH ZWIERZĄT

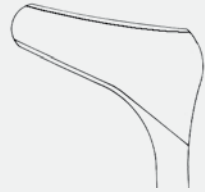

RN-248-001-PMK

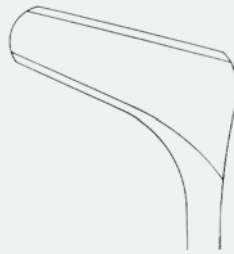

RN-248-002-PMK

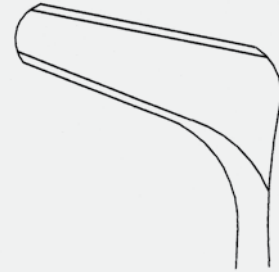

RN-248-003-PMK

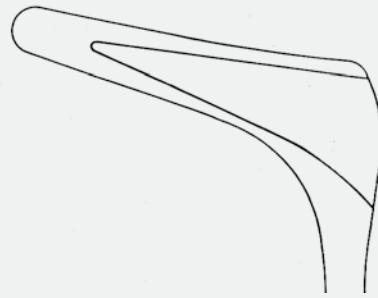

RN-250-001-PMK

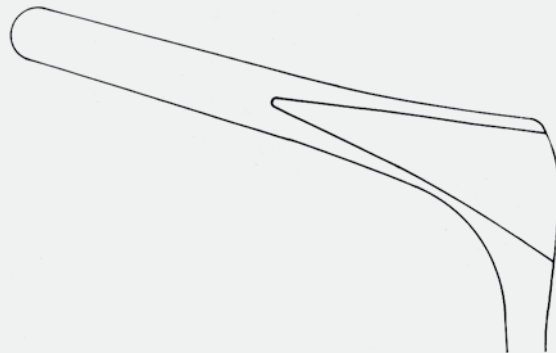

RN-250-002-PMK

OBSTETRIC INSTRUMENTS - NARZĘDZIA PORODOWE



WITT-GERTH

WW-017-450-PN
45 cm, 17 3/4"



HARMS

WW-001-080-PMK
8 cm, 3 1/8"



HARMS

WW-004-065-PMK
6,5 cm, 2 1/2"



HARMS

WW-004-080-PMK
8 cm, 3 1/8"

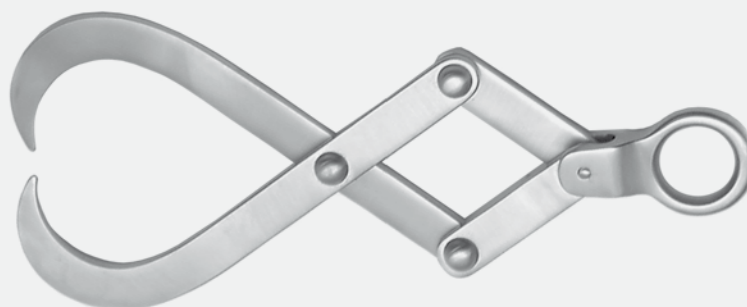

KREY-SCHOTTLER

WW-002-210-PMK
21 cm, 8 1/4"

IGŁA DO SZYCIA
SEWING NEEDLE



GERLACH

WE-010-150-PMS
15 cm, 6"

NOŻYCZKI STRZYKOWE
TEAT SLITTING SCISSORS



CHRESTENSEN

WN-031-155-PB
15,5 cm, 6 1/8"

HOOF CUTTERS
KLESZCZE DO RACIC



WR-024-420-PL
42 cm, 16 1/2"



FRANK
WR-028-400-PN
40 cm,

**HOOF TESTING FORCEPS
KLESZCZE DO BADANIA KOPYT**



WR-037-400-PMK
40,5 cm, 16"



WR-036-380-PN
38 cm, 15"



WR-036-300-PN
30 cm, 11 3/4"

**HEAVY DUTY FOOT ROT
NOŻYCE DO OBCINANIA RACIC OWIEC I KÓZ**



WR-046-240-PL
24 cm, 9 1/2"

WR-246-240-PL
24 cm, 9 1/2"
jedno ostrze ząbkowane
with one blade serrated

SPIS TREŚCI
INDEX

A**ALBRECHTSEN**

uterine tenaculum and dressing forceps, kleszcze ginekologiczne i do materiałów opatrunkowych 41

ALLIS

intestinal and grasping forceps, kleszczyki jelitowe do materiałów opatrunkowych 16

B**BABCOOK**

intestinal and grasping forceps, kleszczyki jelitowe do materiałów opatrunkowych 16

BACKHAUS

towel clamps, spinaki do serwet 13

BARAQUER

eye speculum, rozwórki oczne 35

BAYER

bone rongeur, odgryzacz kostny 27

BEBE

scissors for cutting wire and tape, nożyczki do blachy 31

BEIN

elevator, dźwignia stomatologiczna 29

BLENDINGER

rumen operation forceps, kleszcze do operacji żwacza 36

C**CHRESTENSEN**

teat slitting scissors, nożyczki strzykowe 43

COLLIN

clips applying and removing forceps, kleszcze do klamerek Michela 21

CRILE

hemostatic forceps, kleszczyki naczyniowe, 15

CUSHING

bone rongeur, odgryzacz kostny 27

D**DESCHAMPS**

ligature needles, igły do podwiązywania 22

DESMARRES

blefarostat 33

DIEFFENBACH

bulldog clamps, zaciskacze do naczyń 17

F**FARABEUF**

abdominal hook, hak brzuszny 22

dental hook, hak stomatologiczny 31

FARABEUF - LAMBOTTE

bone holding forceps, kleszcze do trzymania kości 27

FLOHR

elevator, dźwignia stomatologiczna 29

FRANK

hoof cutters, kleszcze do racic 44

G**GERLACH**

sewing needle, igła do szycia 22, 43

GILLIES

needle holders, igłotrzymacze 19

GOSSET

abdominal retractors, haki brzuszne 24

H**HALSTED**

hemostatic forceps, kleszczyki naczyniowe, 14

HARMS

bull holders, poskramiacze dla bydła 1

obstetric hooks, haki porodowe 43

HAUSMAN

castration forceps, kleszcze do kastracji 38

HEGENBARTH

clips applying and removing forceps, kleszcze do klamerek Michela 21

HOHMANN

elevators, podważki kostne 26

K**KREY-SCHOTTLER**

obstetric hook, hak porodowy 43

KOCHER

hemostatic forceps, kleszczyki naczyniowe, 14

intestinal forceps, kleszczyki jelitowe 16

L**LANGENBECK**

surgical hooks, haki chirurgiczne 23

LISTER

dressing scissors, nożyczki do materiałów opatrunkowych 13

LISTON

bone cutting forceps, nożyce kostne 27

LUER - KÖRTE

gall stone scoops, łyżeczki do kamieni 17

LUER - STILLE

bone rongeur, odgryzacz kostny 27

M**MAIER**

sponge and dressing forceps, kleszczyki do materiałów opatrunkowych 17

MATHIEU

needle holders, igłotrzymacze 19, 20

MAYO

surgical scissors, nożyczki chirurgiczne 9

MAYO-HEGAR

needle holders, igłotrzymacze 21

METZENBAUM	
preparatory scissors, nożyczki preparacyjne	11
MICHEL	
clips applying and removing forceps, kleszcze do klamerek Michela	21
MUSEUX	
uterine tenaculum and dressing forceps, kleszcze ginekologiczne i do materiałów opatrunkowych	41
O	
OLSEN-HEGAR	
needle holder with scissors, igłotrzymacz z nożyczką	20
P	
PEAN	
hemostatic forceps, kleszczyki naczyniowe,	14, 15
R	
REIMERS	
castration forceps, kleszcze do kastracji	39
S	
SAND	
castration forceps, kleszcze do kastracji	39
SCHOETTLE	
pig catcher, pętla - poskramiacz dla świń	3
SCHRÖDER	
uterine tenaculum and dressing forceps, kleszcze ginekologiczne i do materiałów opatrunkowych	41
SIMS	
surgical scissors, nożyczki chirurgiczne	10
V	
VERBOCZY	
castration forceps, kleszcze do kastracji	39
VOLKMANN	
bone curettes, łyżeczki kostne	18
WARWICK - JAMES	
elevator, dźwignia stomatologiczna	29
W	
WEINGART	
rumen operation instruments, narzędzia do operacji żwacza	36, 37
WEITLANER	
wound retractors, rozwieracze do ran	24
WILLIGER	
bone curettes, łyżeczki kostne	18
raspatories, skrobaczki stomatologiczne	29
WITT- GERTH	
obstetric forceps, kleszcze porodowe	43

HH-197-045-PMK	24	IM-037-200-PMS	19	KK-032-255-PMK	27
HH-197-057-PMK	24	IM-037-240-PMS	19	KK-035-270-PMK	27
HH-215-150-PMK	22, 31	IM-047-170-PMK	19	KK-055-006-PMK	27
HH-241-028-PMK	23	IM-137-170-PMK	19	KK-058-210-ZMK	27
HH-241-030-PMK	23	IM-138-160-PMK	19	KL-035-240-PMK	41
HH-241-033-PMK	23	IM-235-150-PMK	21	KN-058-160-PMS	14
HH-241-040-PMK	23	IM-236-180-PMK	21	KN-058-160-ZMS	14
HH-257-001-PMK	23	IM-237-205-PMK	21	KN-058-180-PMS	14
HH-257-002-PMK	23	IM-839-140-PMK	20	KN-058-180-ZMS	14
HH-257-003-PMK	23	IM-839-140-ZMK	20	KN-063-160-PMK	14
HH-257-004-PMK	23	IM-920-150-EPZMK	21	KN-063-160-ZMK	14
HH-258-001-PMK	23	IM-920-180-EPZMK	21	KN-063-180-PMK	14
HH-258-002-PMK	23	IM-920-205-EPZMK	21	KN-063-180-ZMK	14
HH-258-003-PMK	23	IM-932-200-PZMK	20	KN-074-160-EPMK	15
HH-258-004-PMK	23	IM-939-140-PZMK	20	KN-074-160-EZMK	15
HO-022-220-LMS	22	IM-947-170-PZMK	20	KN-082-125-XPMK	14
HO-022-220-RMS	22	IM-950-145-PZMK	20	KN-082-125-XZMK	14
HO-023-220-LMS	22	IO-002-110-PMK	32	KN-084-125-XPMK	14
HO-023-220-RMS	22	IO-002-110-ZMK	32	KN-084-125-XZMK	14
HO-058-155-PMK	16	IO-013-110-PMK	32	KN-088-140-PMK	15
HO-065-155-PMK	16	KE-201-000-PB	30	KN-088-140-ZMK	15
HO-069-006-PMS	17	KE-217-000-PB	30	KN-201-165-PMK	15
HO-069-007-PMS	17	KE-218-000-PB	30	KN-412-130-EPMK	15
HO-069-011-PMS	17	KE-222-000-PB	30	KN-412-130-EZMK	15
HO-070-200-PMK	16	KE-230-000-PB	30	KN-424-140-EPMK	15
HO-075-170-PMS	8	KE-233-000-PB	30	KN-425-140-EZMK	15
HO-128-090-EPMK	13	KG-014-006-PMK	41	KP-100-160-PMK	28
HO-128-110-EPMK	13	KG-014-008-PMK	41	LK-103-028-PMK	18
HO-128-135-PMK	13	KG-014-010-PMK	41	LK-103-036-PMK	18
HO-135-125-PMK	21	KG-027-240-PMK	17	LK-103-044-PMK	18
HO-138-135-PMK	21	KG-027-240-ZMK	17	LK-103-052-PMK	18
HO-139-130-ZMK	21	KG-028-265-PMK	17	LK-103-068-PMK	18
HO-148-215-PMK	16	KG-028-265-ZMK	17	LK-103-085-PMK	18
HO-148-245-PMK	16	KG-114-006-KMK	41	LK-103-100-PMK	18
HO-149-215-ZMK	16	KG-114-008-KMK	41	LK-103-115-PMK	18
HO-149-245-ZMK	16	KG-114-010-KMK	41	LK-103-130-PMK	18
IM-032-200-PMS	19	KK-017-180-PMK	27	LK-103-145-PMK	18

LK-152-140-PMK	18	NH-085-230-ZMK	10	NO-051-110-PMK	34
LK-155-145-PMK	18	NH-086-200-PMK	10	NO-051-110-ZMK	34
LK-156-145-PMK	18	NH-086-200-ZMK	10	NP-072-110-PMK	31
LK-156-170-PMK	18	NH-086-230-PMK	10	NP-072-110-ZMK	31
MO-009-090-EZMS	5	NH-086-230-ZMK	10	NP-076-110-PMK	31
MO-009-100-EZMS	5	NH-095-130-PMK	12	NP-076-110-ZMK	31
MO-009-110-EZMS	5	NH-279-130-EPMK	10	NP-077-120-PMK	31
MO-011-135-PMS	4	NH-279-130-EZMK	10	NS-014-230-PMK	12
MO-024-155-XPMK	4	NH-279-145-EPMK	10	NS-110-115-PMK	12
MO-133-142-PMS	4	NH-279-145-EZMK	10	OP-022-270-PMS	26
MO-211-135-PMS	4	NH-279-165-PMK	10	OP-033-175-PMK	28
MP-011-003-PMK	32	NH-279-165-ZMK	10	OP-035-140-PMK	28
MP-012-002-PMK	32	NH-280-130-EZMK	10	OP-035-180-PMK	28
MP-020-002-ZMK	33	NH-280-130-PMK	10	OP-050-004-PMK	25
MP-070-030-PMK	33	NH-280-145-EPMK	10	OP-050-006-PMK	25
MP-253-018-PMK	33	NH-280-145-EZMK	10	OP-050-008-PMK	25
NF-001-160-PMK	7	NH-280-165-PMK	10	OP-050-010-PMK	25
NF-004-140-PMK	7	NH-280-165-ZMK	10	OP-050-012-PMK	25
NH-073-210-PMK	13	NH-281-130-PMK	11	OP-080-902-PMS	26
NH-074-145-PMK	13	NH-281-130-ZMK	11	OP-081-902-PMS	26
NH-074-180-PMK	13	NH-281-145-EPMK	11	OP-930-020-PZMS	28
NH-076-130-PMK	13	NH-281-145-ZMK	11	OP-931-020-PZMS	28
NH-076-145-PMK	13	NH-281-165-PMK	11	OP-935-475-PMK	28
NH-076-185-PMK	13	NH-281-165-ZMK	11	PO-001-005-PMK	33
NH-078-140-PMK	9	NN-148-145-PMK	11	PO-011-005-PMK	35
NH-078-140-ZMK	9	NN-148-145-ZMK	11	PO-011-005-ZMK	35
NH-078-170-PMK	9	NN-185-160-PMK	11	PO-022-002-PMK	35
NH-078-170-ZMK	9	NN-185-160-ZMK	11	PO-022-002-ZMK	35
NH-079-185-PMK	10	NN-185-185-PMK	11	PO-036-010-KMK	35
NH-079-185-ZMK	10	NN-185-185-ZMK	11	RH-299-135-PMK	24
NH-080-185-PMK	10	NO-003-120-PMK	34	RH-299-165-PMK	24
NH-080-185-ZMK	10	NO-003-120-ZMK	34	RN-248-001-PMK	42
NH-081-185-PMK	11	NO-010-085-PMK	34	RN-248-002-PMK	42
NH-081-185-ZMK	11	NO-010-085-UMK	34	RN-248-003-PMK	42
NH-085-200-PMK	10	NO-010-085-ZMK	34	RN-250-001-PMK	42
NH-085-200-ZMK	10	NO-022-110-LMK	34	RN-250-002-PMK	42
NH-085-230-PMK	10	NO-022-110-RMK	34	RO-001-005-PB	35

RO-001-009-PB	35	WE-128-135-PMK	5	WR-246-240-PL	45
RO-001-012-PB	35	WE-135-200-PS	1	WS-001-040-PMK	3
SD-002-003-PT	29	WE-139-160-ZMK	6	WS-001-067-PMK	3
SD-004-003-LT	29	WE-142-320-PN	2	WS-001-105-PMK	3
SD-005-003-RT	29	WE-150-058-PN	2	WS-001-150-PMK	3
SD-033-002-PT	29	WE-239-160-ZMK	6	WS-001-175-PMK	3
ST-010-140-PMK	29	WH-002-620-PMK	35	WT-032-155-PT	31
ST-011-160-PMK	29	WK-010-170-PMS	40	WW-001-080-PMK	43
TH-095-003-PMK	9	WK-020-360-PN	40	WW-002-210-PMK	43
TH-096-004-PMK	9	WK-020-400-PN	40	WW-004-065-PMS	43
TH-097-003-PMK	9	WK-020-480-PN	40	WW-004-080-PMK	43
TH-195-003-PMK	9	WK-021-300-PN	40	WW-017-450-PN	43
TH-196-004-PMK	9	WK-022-220-PN	40	WZ-001-280-PMK	37
TH-197-003-PMK	9	WK-023-125-PN	40	WZ-002-080-PMK	36
WE-003-901-PMS	36	WK-026-185-ZT	38	WZ-004-240-PMK	37
WE-010-150-PMS	22, 43	WK-026-195-PT	38	WZ-023-195-PMK	36
WE-011-004-PN	3	WK-026-310-ZT	38	ZK-001-060-PMS	17
WE-012-005-PN	3	WK-026-330-PT	38	ZK-101-060-ZMS	17
WE-028-135-PMK	5	WK-027-310-ZT	39	ZK-002-040-PMS	17
WE-030-265-PN	1	WK-034-230-PT	38	ZK-102-040-ZMS	17
WE-033-045-PN	1	WK-034-265-ZT	38		
WE-035-200-PS	1	WK-034-270-PT	38		
WE-038-170-PMK	6	WK-120-400-PN	40		
WE-039-160-ZMK	6	WK-120-480-PN	40		
WE-040-051-PN	2	WK-124-310-PT	39		
WE-042-320-PN	2	WK-125-310-PT	39		
WE-045-155-ZMK	7	WK-126-310-PT	39		
WE-045-170-ZMK	7	WK-227-310-ZT	39		
WE-048-000-PS	5	WN-031-155-PB	43		
WE-048-001-PS	5	WP-001-901-PL	4		
WE-048-002-PS	5	WP-018-430-PMK	41		
WE-048-003-PS	5	WR-024-420-PL	44		
WE-048-004-PS	5	WR-028-400-PN	44		
WE-050-058-PN	2	WR-036-300-PN	45		
WE-068-170-EPMS	6	WR-036-380-PN	45		
WE-069-135-EZMS	6	WR-037-400-PMK	45		
WE-069-160-ZMK	6	WR-046-240-PL	45		

AESCULAP CHIFA Sp. z o.o.

ul. Tysiąclecia 14,
64-300 Nowy Tomyśl,

tel. 061 44 20 100

fax 061 44 23 936

e-mail: info.acp@bbraun.com

www.chifa.com.pl